

NOTE: FOR MORE DETAILS SEE YOUR V.P. CUSTOMER SERVICE REP.

REVISIONS			
REV.	DESCRIPTION	DATE	APPROVED
A	ECO 0040	06-27-01	
B	CO 031 Drafting Update	01-17-06	Rick C.

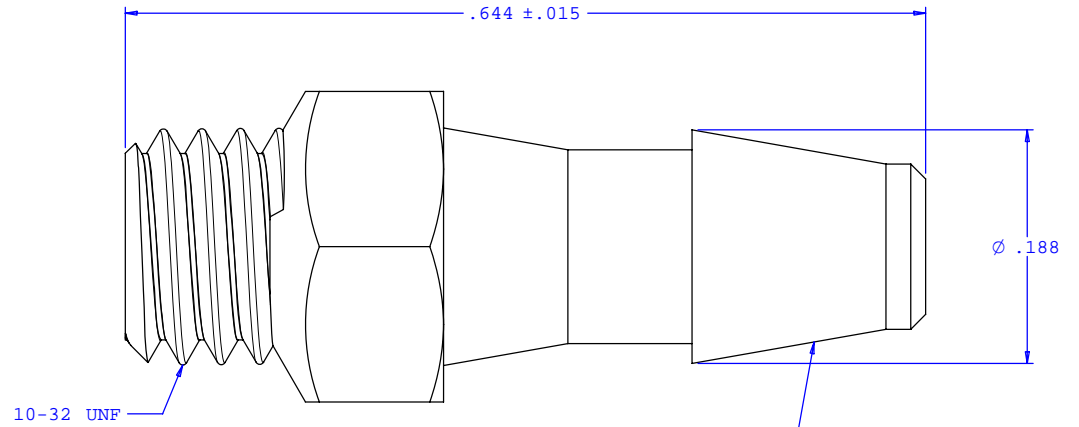

INSTRUMENT QUALITY PART. NO PARTING LINE PERMITTED ON THIS CONICAL SURFACE

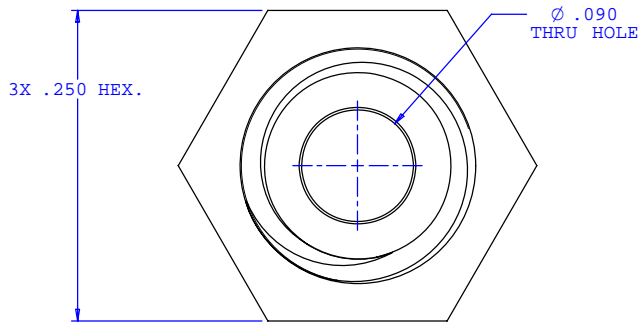
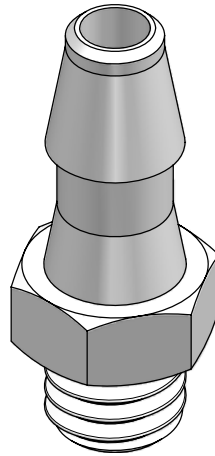

UNLESS OTHERWISE SPECIFIED DIMENSIONS ARE IN INCHES TOLERANCES ARE:		VALUE PLASTICS, INC.	
FRACTIONS ±	DECIMALS .XX ±.01 .XXX ±.005 .XXXX ±.001	ANGULAR ±1°	PART NUMBER: K230
DO NOT SCALE DRAWING		DESCRIPTION: 10-32 UNF Thread with 1/4" Hex to 200 Series Barb, 1/8" (3 mm) ID Tubing	
DRAWN BY: Frank Lombardi	DATE: 11-18-05	SIZE: B	SCALE: NTS
Engineer/Manager: Rick Cairns		DRAWING NUMBER: 1007852	REV. B
© 2005 VALUE PLASTICS, INC.		SHEET: 1 OF 1	

FOR REFERENCE ONLY