

NOTE: FOR MORE DETAILS SEE YOUR V.P.CUSTOMER SERVICE REP.

REVISIONS			
REV.	DESCRIPTION	DATE	APPROVED
A	INITIAL RELEASE	12-19-97	
B	CO 016 Drafting Update	06-14-05	Rick C.

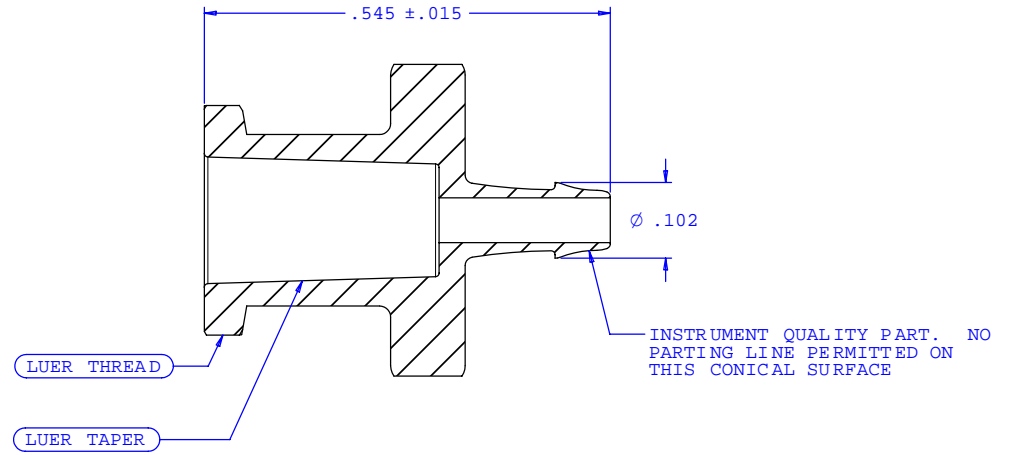

SECTION B-B

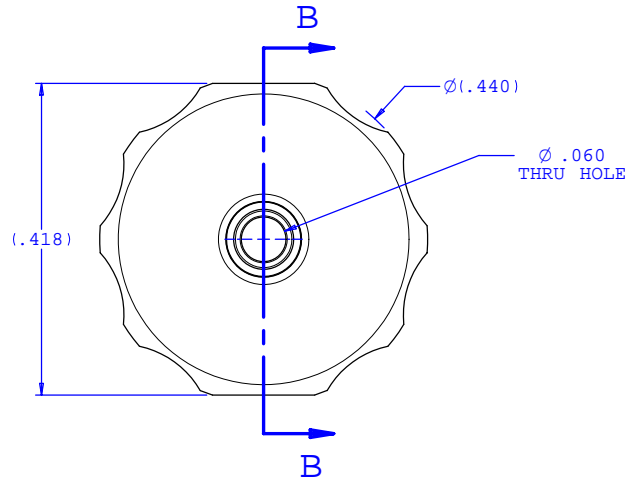
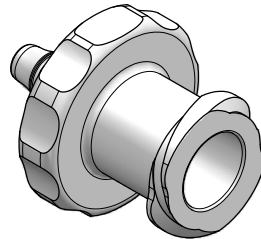

UNLESS OTHERWISE SPECIFIED DIMENSIONS ARE IN INCHES TOLERANCES ARE:		VALUE PLASTICS, INC.	
FRACTIONS ±	DECIMALS .XX ±.01 .XXX ±.005 .XXXX ±.001	ANGULAR ±1°	PART NUMBER: FTLL004
DO NOT SCALE DRAWING		DESCRIPTION: Female Luer Thread Style to 500 Series Barb, 1/16" (1.5 mm) ID Tubing	
DRAWN BY: Frank Lombardi 05-06-05	DATE:	SIZE: B	SCALE: NTS
Engineer/Manager: Rick Cairns		DRAWING NUMBER: 1006632	REV. B
		© 2005 VALUE PLASTICS, INC.	SHEET: 1 OF 1

FOR REFERENCE ONLY